



## SESSION 2: HOW TO SAIL

Ginny Perry Worcester

# SAFETY AT SEA TOPICS

## Community Sailing of Fairfield



# PARTS OF THE BOAT

## PARTS OF THE BOAT

Let's begin by learning some of the important parts on a boat and their names. Knowing some of these sailing terms will allow you to communicate better when on board the boat. Here's a quick overview.

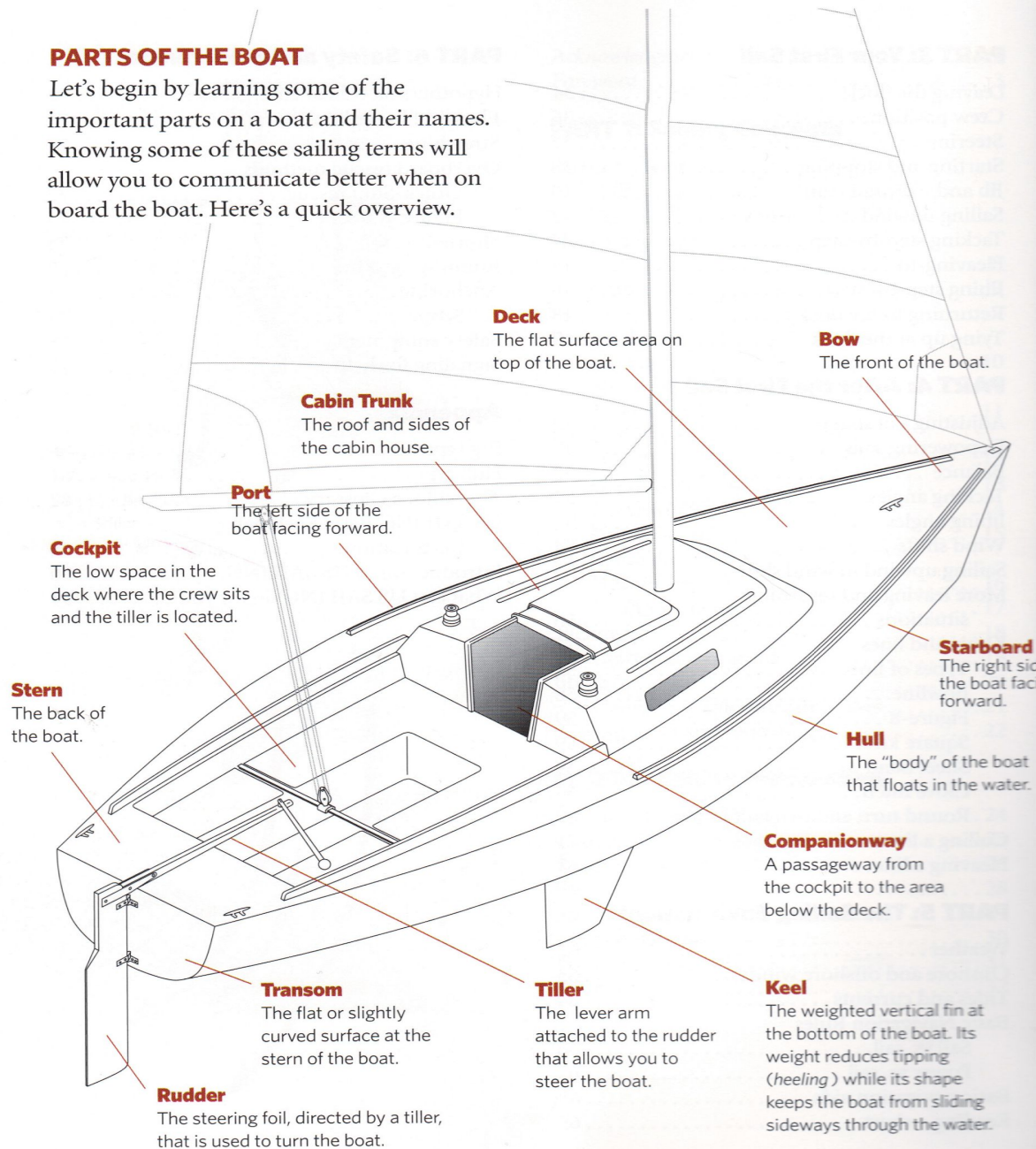

# PARTS OF THE RIG

## PARTS OF THE RIG

Now that you know your way around the deck, it's time to look up. The *rig* includes sails (*mainsail* and *jib*), spars (*mast* and *boom*), supporting wires (*standing rigging*) and sail controls (*running rigging*).

### Forestay

The part of the rigging that is attached to the bow of the boat that keeps the mast from falling backward.

### Jib

The forward sail that is attached to the forestay.

### Spreader

Struts that extend from the side of the mast that keep it from bending sideways.

### Telltails

Pieces of cloth, yarn, or tape that indicate wind flow over a sail.

### Shrouds

Rigging wires extending up from the sides of the boat to the mast that keep the mast from falling to either side.

### Boom

The horizontal spar extending back from the mast. The foot (*bottom*) of the mainsail is attached to it.

### Mast

The vertical spar in the middle of the boat from which the sails are set.

### Mainsail

The sail hoisted on the back side of the mast and attached to the boom.

### Batten

A slat of fiberglass, plastic or wood inserted into a pocket in the sail to help it hold its shape.

### Telltails

### Backstay

The part of the rigging, attached from the top of the mast to the stern of the boat, that keeps the mast from falling forward.

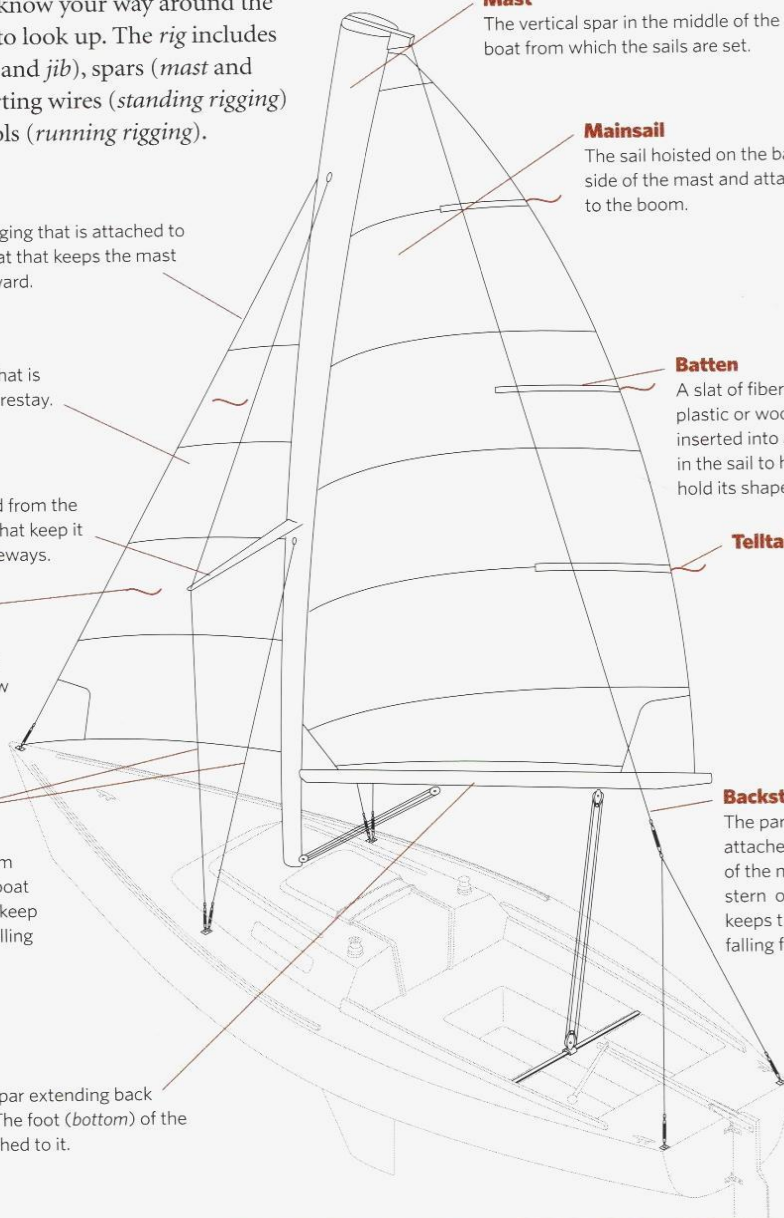

# WHAT MAKES A SAILBOAT SAIL VIDEO



# Points of Sail

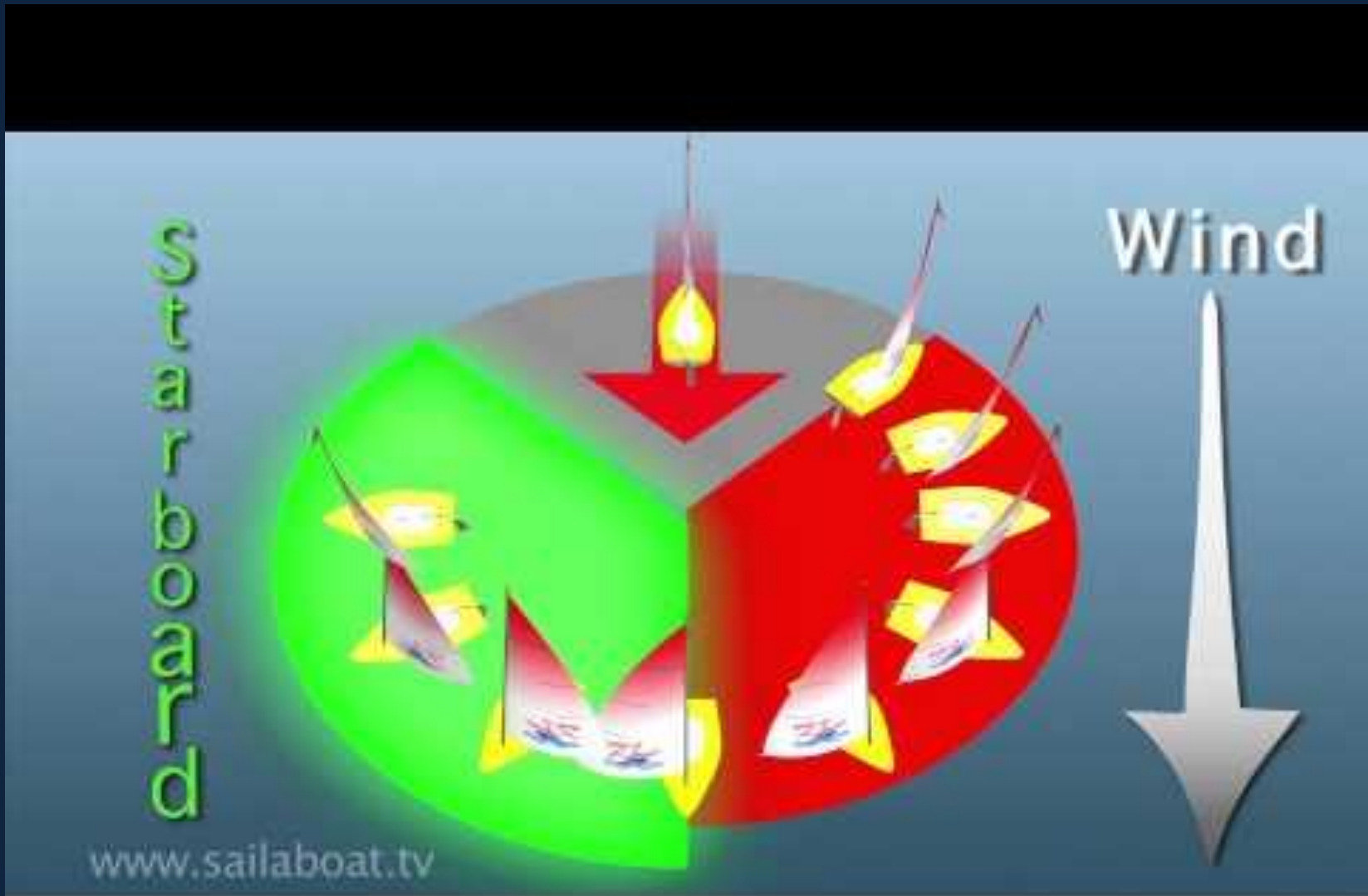

## PROPER SAIL TRIM

- An over-trimmed sail loses power through turbulence on the leeward side.
- An under-trimmed sail luffs and loses power.
- A properly trimmed sail has smooth airflow around both sides.

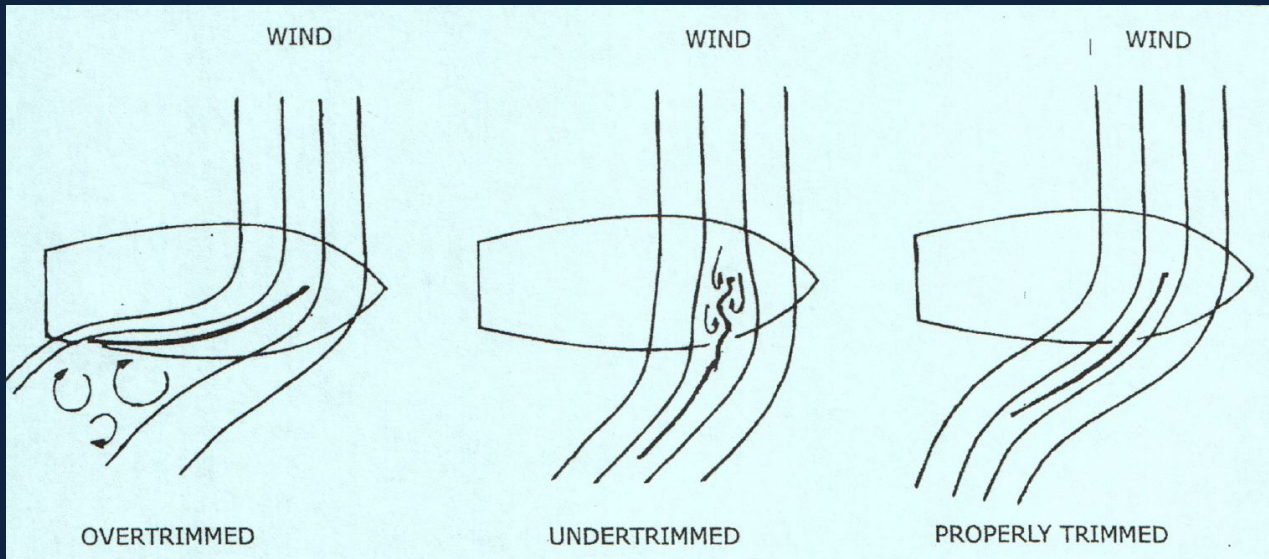

# Points of Sail

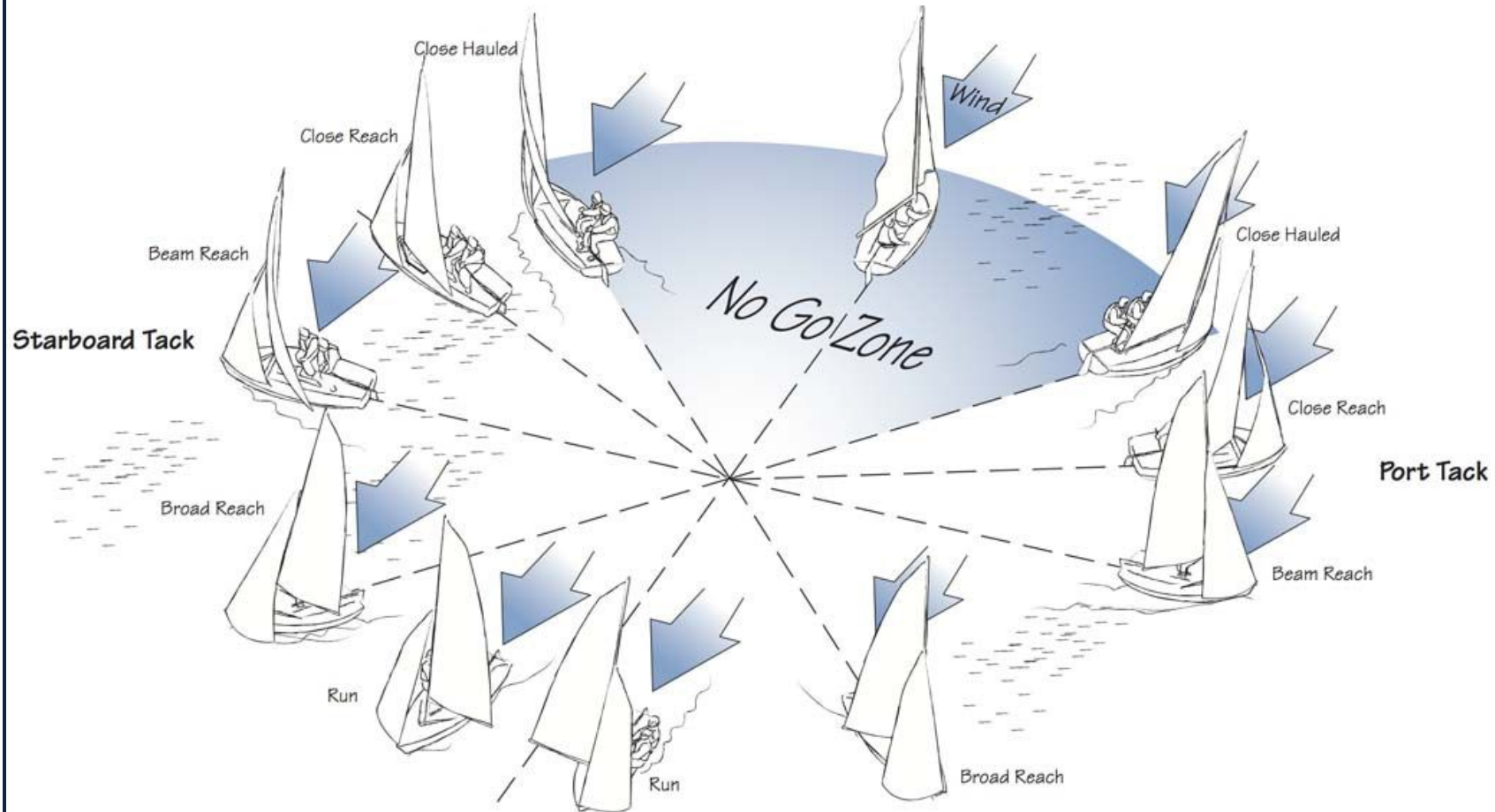



# WINDWARD & LEEWARD

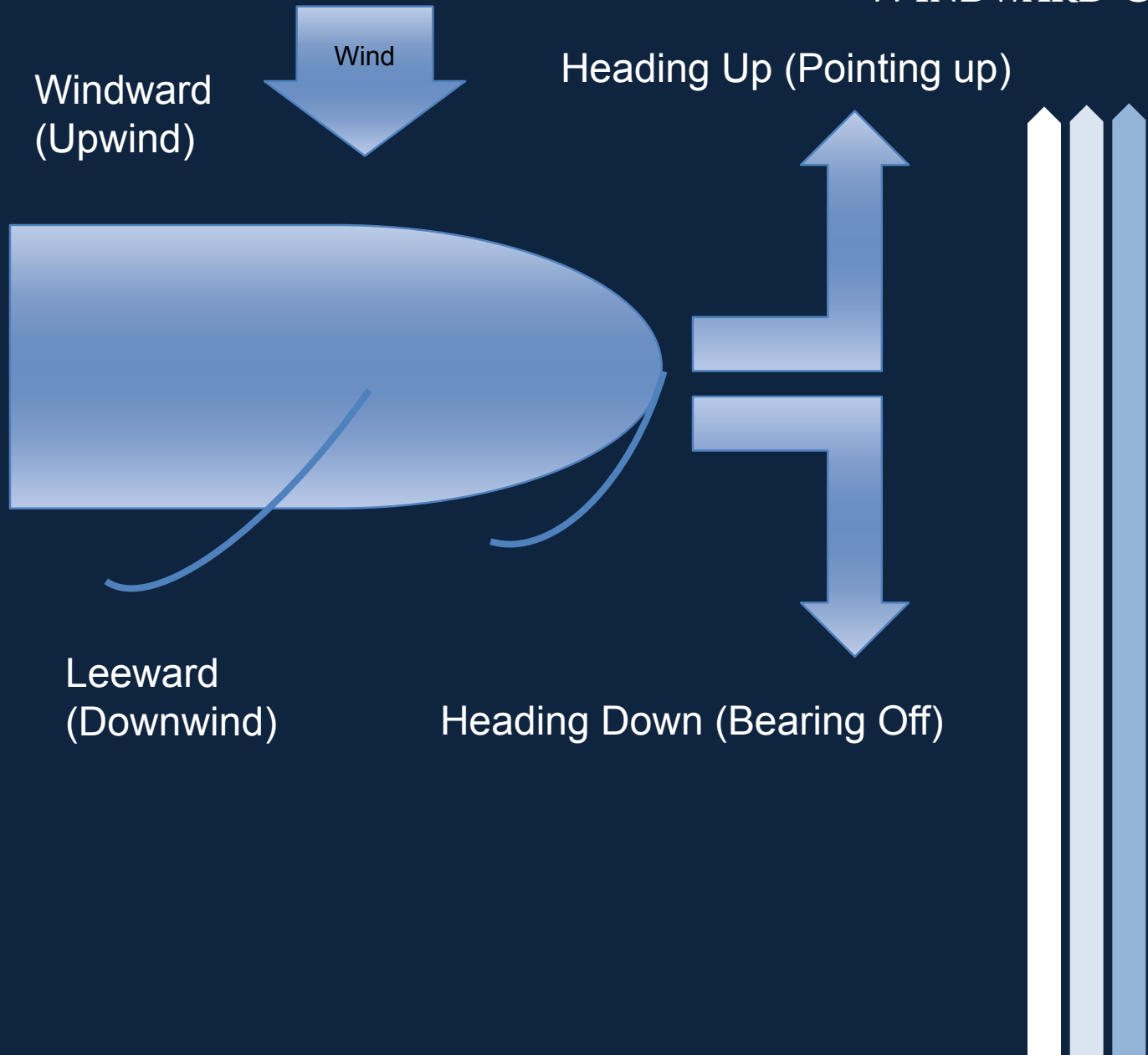

Windward  
(Upwind)

Wind

Heading Up (Pointing up)

Leeward  
(Downwind)

Heading Down (Bearing Off)



Wind

### POINTS OF SAIL

These are the terms used to describe the angle of the boat and sails, relative to the wind

**HEAD TO WIND**  
If we're moving through this position we're "in stays", if we're stalled we're "in irons".



We can't sail straight into the wind so must zig-zag or TACK.

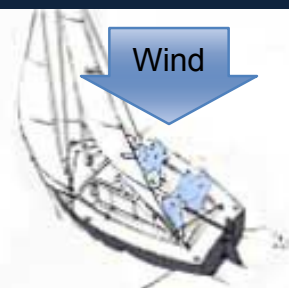

The distance between tacks is sometimes called a BOARD



**CLOSE HAULED**  
sailing as close to the wind as possible, roughly 30deg

**BEAM REACH**  
wind coming over the side at roughly 90deg

**BROAD REACH**  
wind coming over the back corner

To turn away from the wind is **BEARING AWAY**



**RUNNING**  
sailing directly away from the wind is known as 'running before the wind' or being on a 'dead run'



To turn the back of the boat through the wind so the sail changes sides is known as **GYBING**



# SAILING UPWIND, ACROSS THE WIND & DOWNWIND



# SAILING UPWIND



# TIPS FOR SAILING UPWIND

- Keep pushing the tiller toward the sail till it starts to luff or the inside telltale lifts, then bring the tiller back toward you a little.
- Telltales should be flowing back together, parallel to one another.
- If the outside one droops, head up (or push the tiller toward the sail).
- Sail as close to the wind as possible before you tack.
- Keep your eyes looking forward, out of the boat.
- The sails should be trimmed in all the way. If you start heeling, get your weight to the windward side and ease the main sheet till the sail starts to luff, spilling the wind out of the sail.

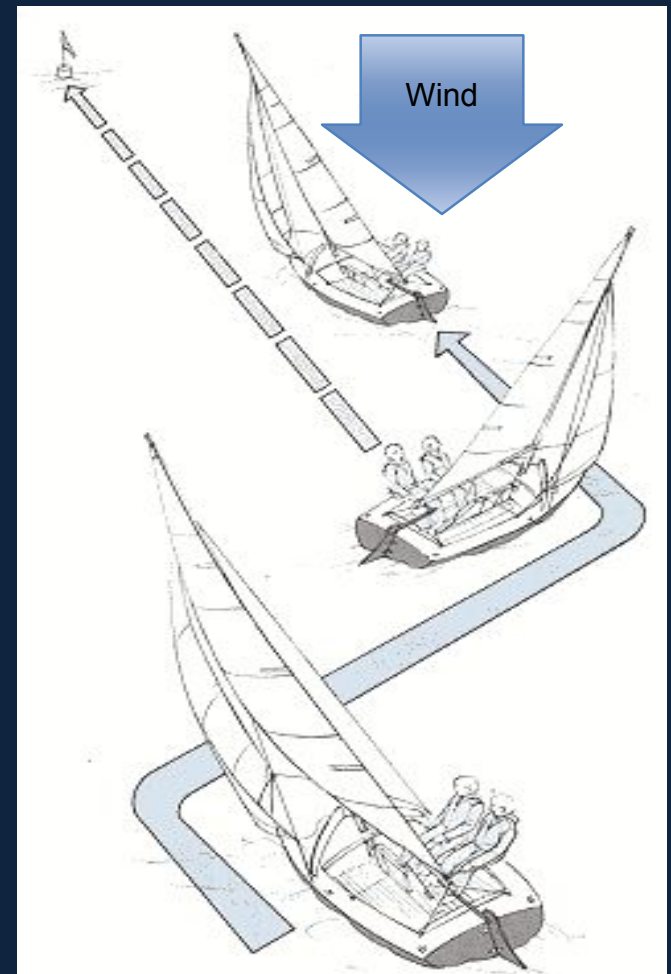

# Tacking



# TACKING

CHANGING THE DIRECTION OF THE BOAT BY FIRST TURNING THE BOW TOWARD THE WIND (HEADING UP), THEN THROUGH THE WIND AND NO GO ZONE, AND AWAY FROM THE WIND (BEARING AWAY) TO A NEW DIRECTION

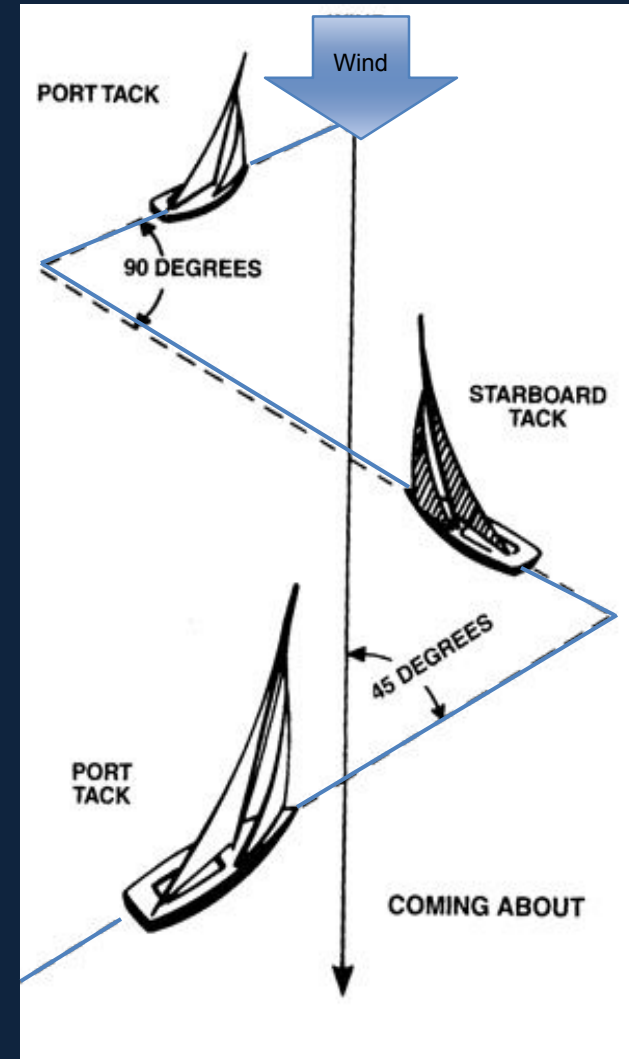
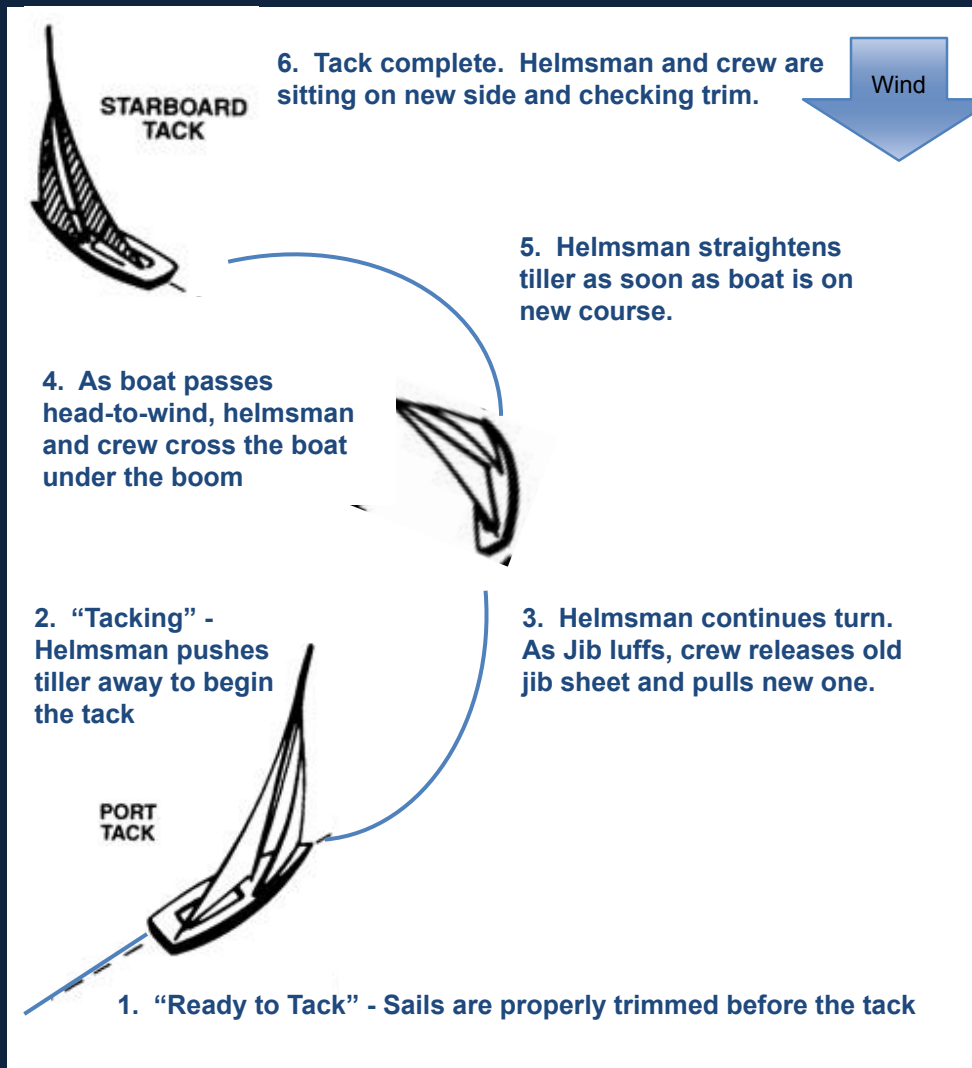

Sailing Out – wind from SW





# SAILING ON A REACH



Beam reach

www.sailaboat.tv

# TIPS FOR SAILING ON A REACH

- Head straight for an object and ease your sails out until they are just about to luff.
- This is the best and easiest point of sail. Your sails are about halfway out, you are not heeling over and the boom is off to the side.
- From this position, you can let the sails out all the way to stop the boat. This is called the “safety position”.

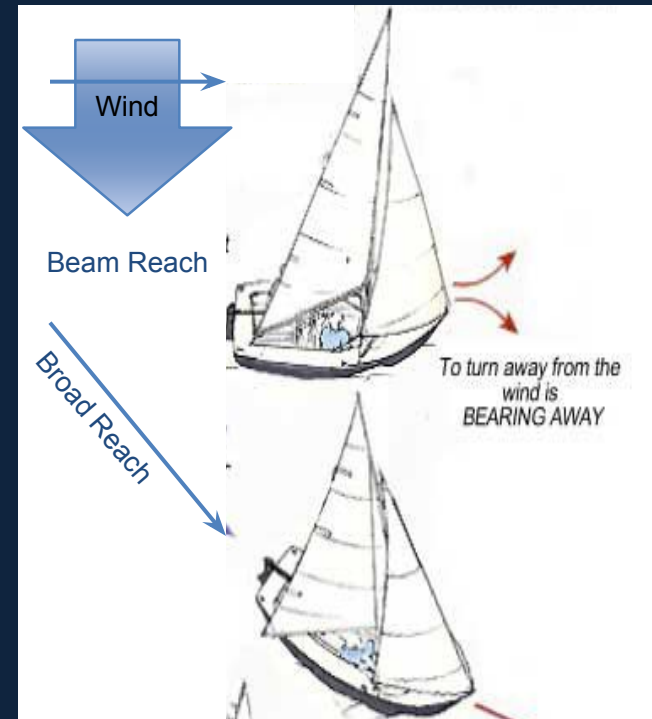

# STOPPING-STARTING & THE SAFETY POSITION

## Stop

Boat is stopped in the water with its sheets eased out and its sails completely luffing.

## Start

Sheeting in the sails to their proper trim gets the boat moving.

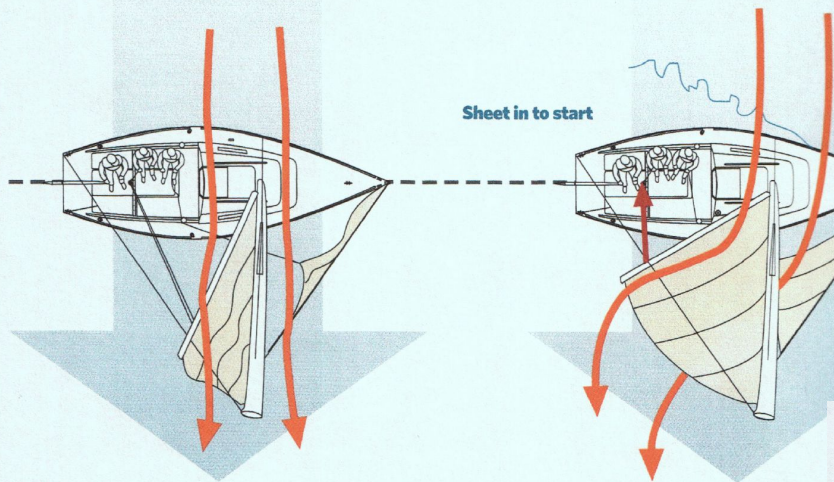

## Stop

To stop the boat the sails are eased out until they are luffing. The boat then coasts to a stop.

## Head up into No-Go Zone to stop

To stop the boat head up directly into the No-Go Zone. The sails luff completely and the boat stops. To stop the boat more quickly, a crew member pushes (backs) the mainsail against the wind (shown).

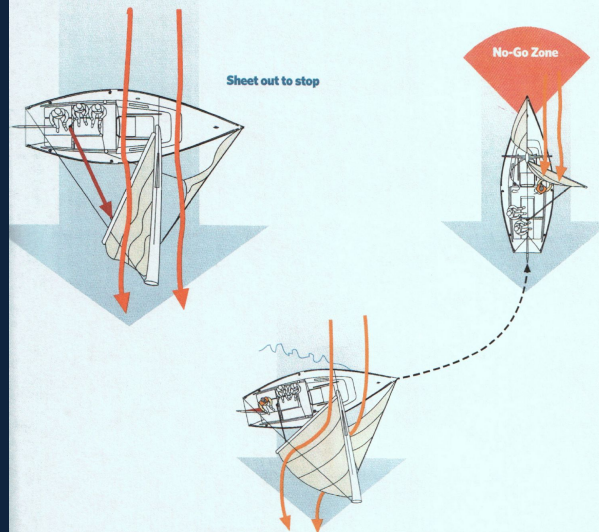

# SAILING DOWNWIND



# TIPS FOR SAILING DOWNWIND

- The wind is behind you, the sails are all the way out.
- It is the slowest and hottest point of sail! Drink water to cool off!
- Head straight for an object.
- Watch out for the accidental jibe. You know you are about to jibe when the jib starts to come over to the other side. If you don't want to jibe, just push the tiller toward the sail a little and that will keep you on an angle where you don't jibe.
- You should always know when you want to jibe.
- Do a controlled jibe maneuver by pulling the main before you jibe and then let it out after you jibe. Never let go of the tiller.

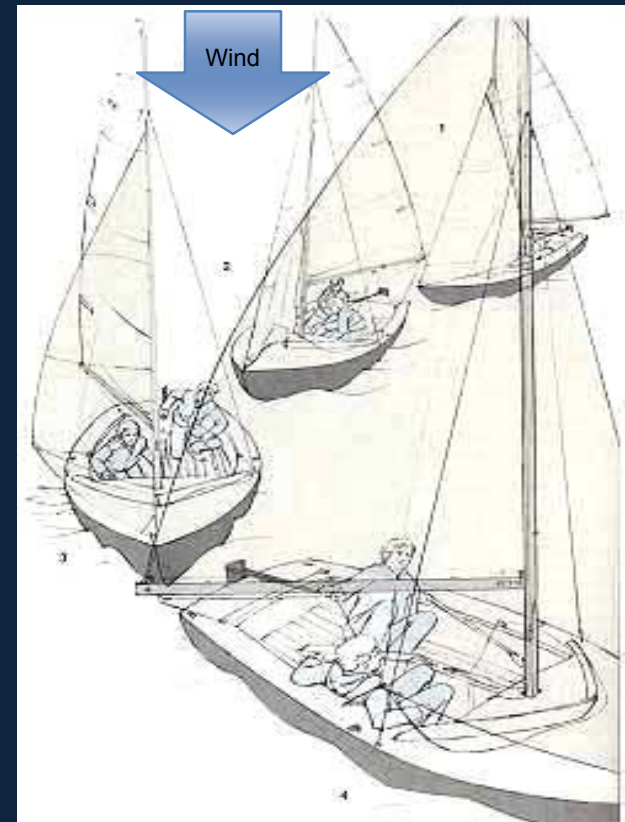

# Jibing



# JIBING

## CHANGING THE DIRECTION OF THE BOAT WHILE PASSING THE STERN THROUGH THE WIND

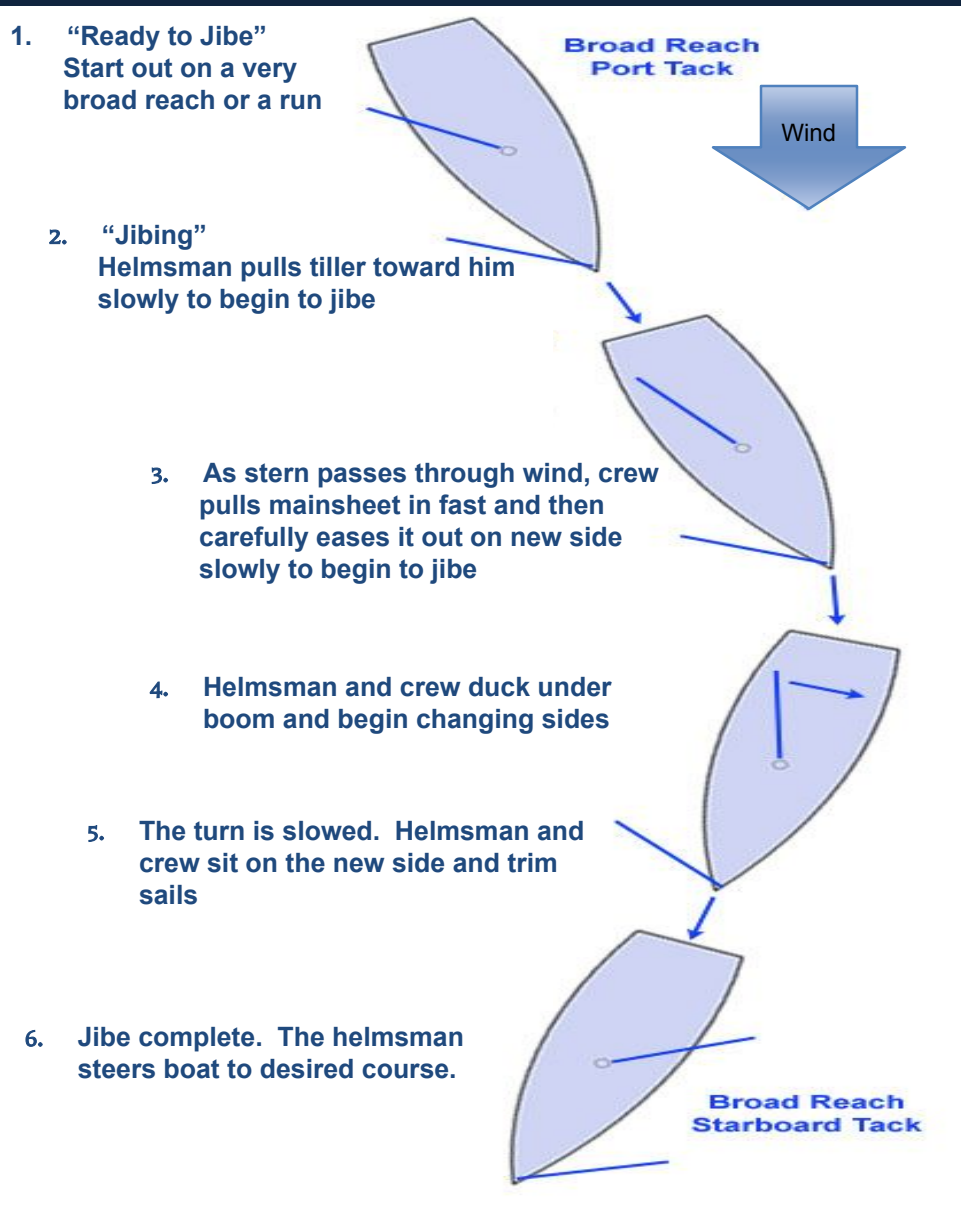

## TAKING OFF

- Your sails are up and luffing as you are tied to the dock pointed into wind. Release the bow line first, and then step aboard at the shrouds or stern while helping to push the boat away from the dock.
- Sheet in the jib on the dock (right) side until the sail becomes backwinded and the boat slowly rotates out of the No-Go zone. Release the stern line from the position on the boat. Double the line back to the boat so it can easily be released.
- Finally, sheet in the jib on the other side, and trim the mainsail, to propel you forward.

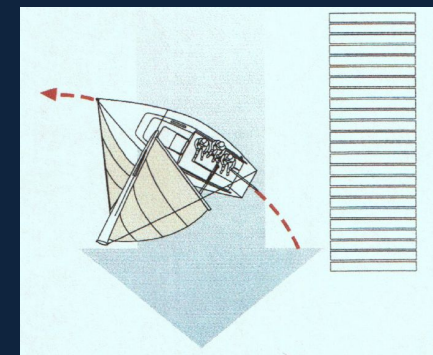
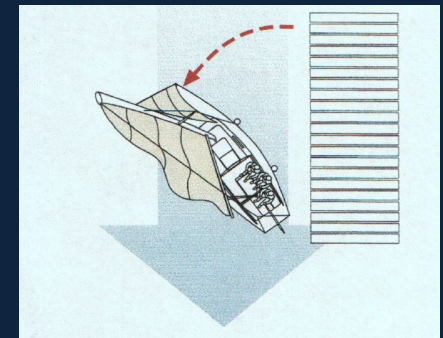
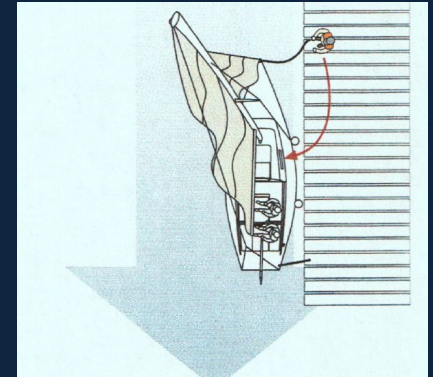



# LANDING

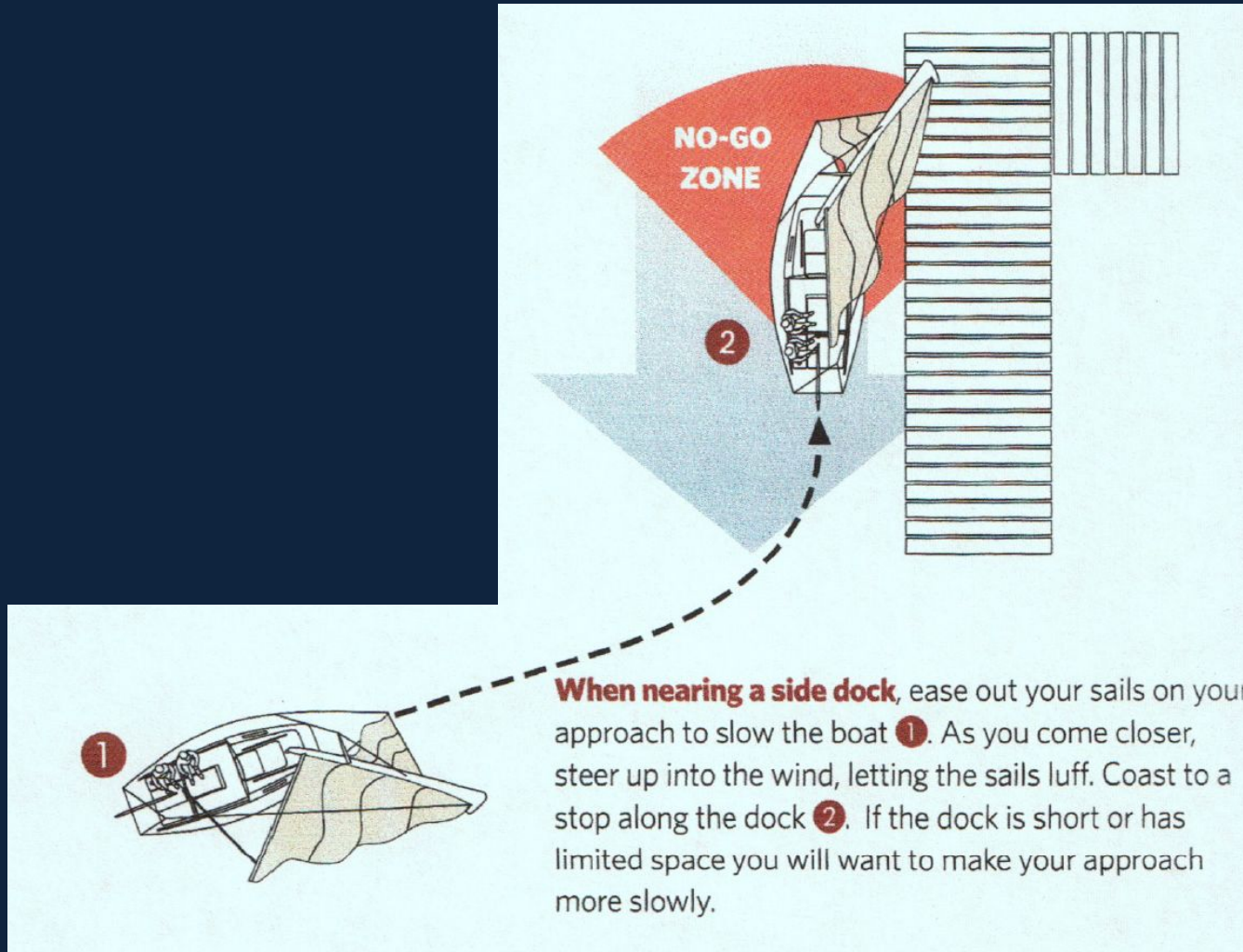



*Community Sailing of Fairfield*

## STOPPING & STARTING

- A sailboat will only coast to a stop when its sails are fully luffing & when the hull has used up all of its momentum.
- The bow must be turned into the wind (within 45 degrees) AND
- All sheets must be released, so the sails can luff freely
- Remember: A sailboat cannot stop when headed downwind

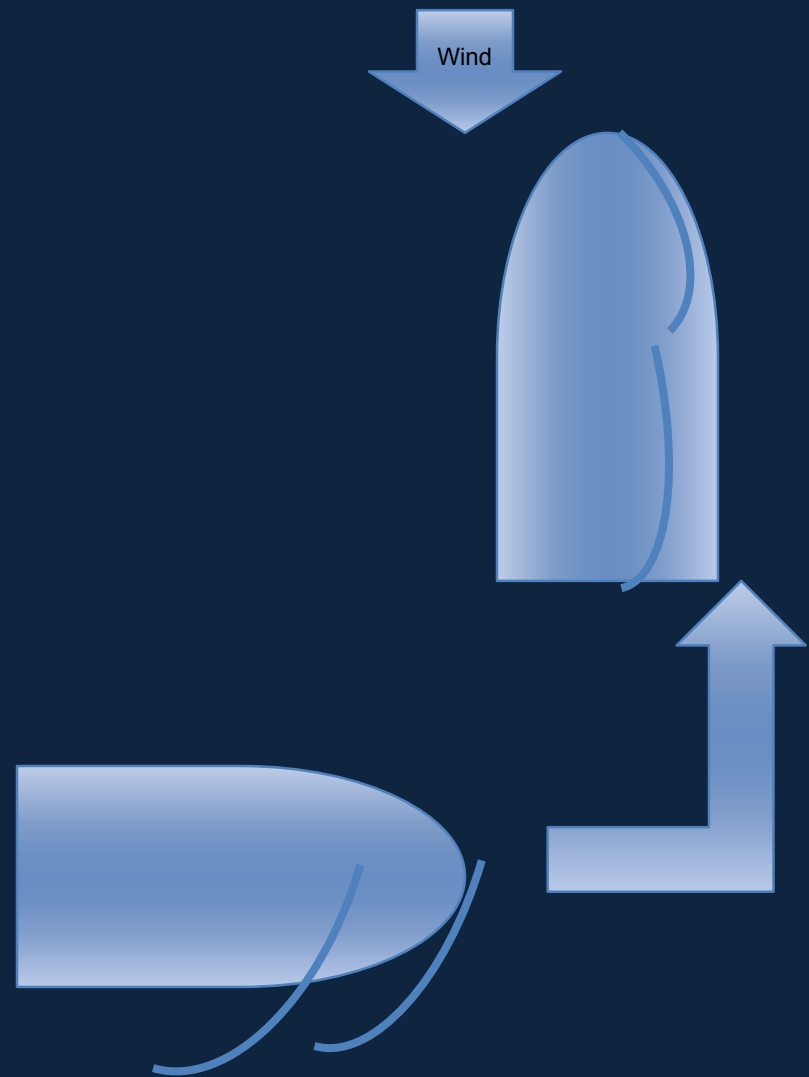

# LANDING – wind from SW

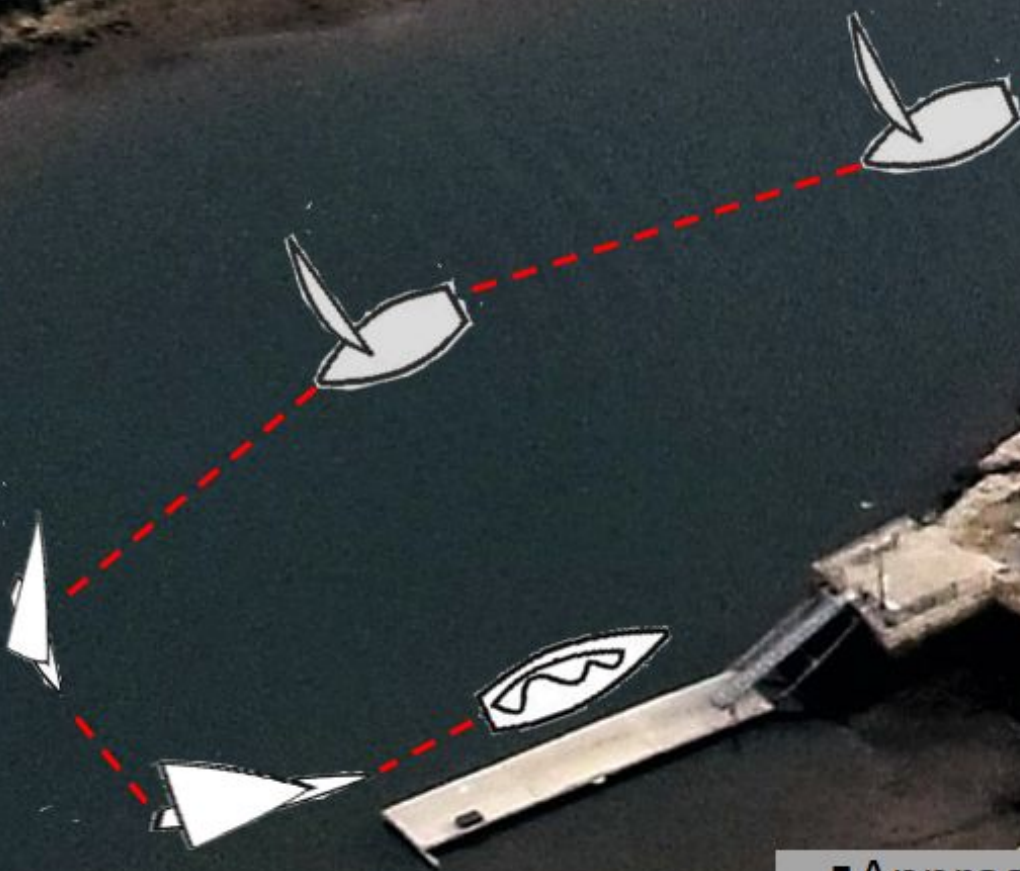

- Approach on broad reach, Port tack
- Furl jib before passing YYY flagpole
- Stay wide of the dock making slow turn to port, maintaining enough way on to glide in parallel to the dock

# LANDING – wind from NNW



1. Come in harbor close-hauled on port tack.
2. Tack to stb when abeam of the dock ramp.
3. Turn head to wind and land parallel to dock letting the both sails luff.

# LANDING – wind from East Option #1

WIND



1. Come down harbor on starboard reach
2. Head up toward CC of Fairfield – head to wind and drop main
3. Keep jib out and tack and head toward end of dock
4. Roll jib and land at dock, heading toward harbor mouth

# LANDING – wind from East Option #2

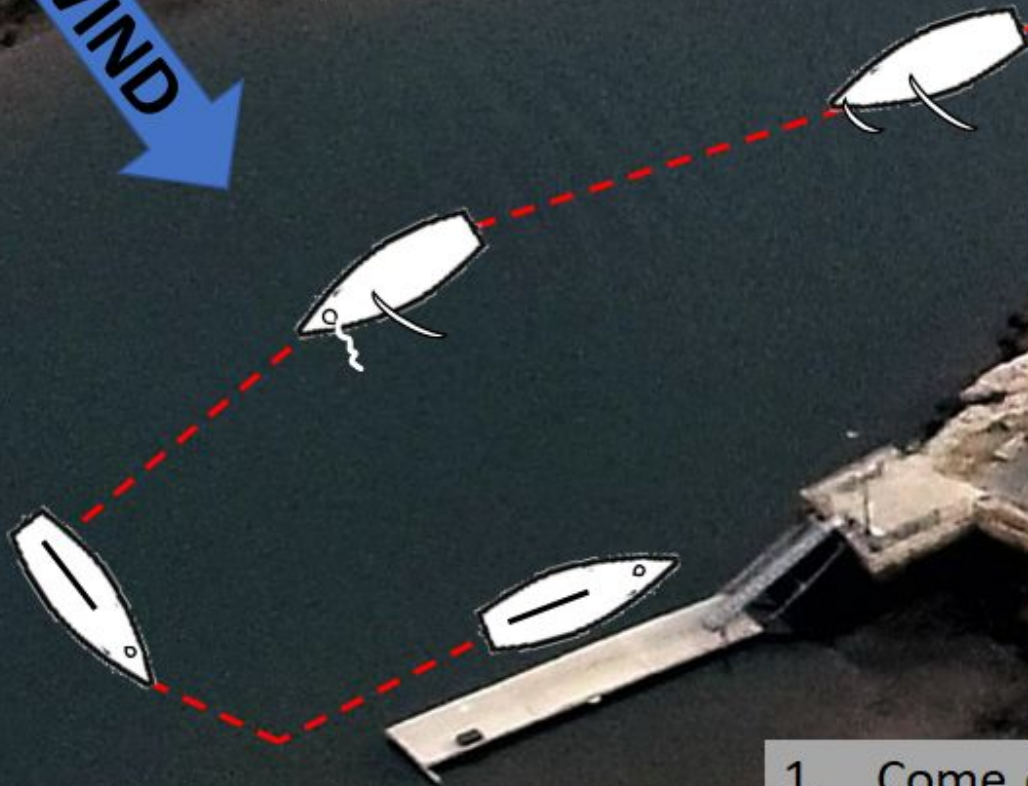

1. Come down harbor on stb reach, staying as wide as possible.
2. Just past dock, over-trim main & roll up jib
3. Land with main sheeted tight in.

# LANDING – wind from East Option #3 (*high-tide only*)

WIND



1. Come down harbor on a starboard reach, staying as wide as possible.
2. Just past dock, over-trim main & roll up jib.
3. Carry on past dock and turn toward YYY and make a quick turn to land on the end of the dock.



## SAILING TERMINOLOGY

- **Back** – To push a sail out against the wind to help turn the boat.
- **Beam Reach** – Sailing at approximately 90 degrees to the wind source with the wind coming from abeam and the sails let out about halfway. (One of the points of sail.)
- **Beam-** The widest dimension of the hull of a boat.
- **Bear Away-** The act of steering a boat away from the wind.
- **Beating** – Sailing toward the wind source, or against the wind, with the sail pulled in all the way, tacking as you go, to reach destination upwind.
- **Boom Vang** – A control line, usually a multi-purchase tackle, secured to the boom to prevent it from lifting when the wind hits the sail.

## SAILING TERMINOLOGY

- **Bow-** The front portion of a boat.
- **Broad Reach** – Sailing with the wind coming over the rear corner of the boat, or with the bow approximately 135 degrees to the wind source. (One of the points of sail.)
- **Cast-Off** – To untie a line and let it go, or to remove a line from a cleat and let it go.
- **Close-Hauled:** Describes a boat sailing as close to the wind as possible with its sails pulled in all the way. Syn. *On the Wind, Sailing to Weather, Sailing to Windward, Sailing Upwind*
- **Close Reach:** Sailing with the wind just forward of abeam, or the bow approximately 70 degrees to the wind source. (One of the points of sail.)
- **Come About:** To turn the bow of a sailboat through the wind, or no-go-zone, so that the sails fill on the opposite side. Syn. *Tack*

## SAILING TERMINOLOGY

- **Downwind:** In the opposite direction from the wind source, or where the wind is blowing to. *Syn. Leeward.*
- **Ease:** To let out a line or sail.
- **Feathering:** Sailing upwind so close to the wind that the forward edge of the sail is stalling or luffing, reducing the power generated by the sail and the angle of heel. *Syn. High, Light, Pinching, Sailing Thin.*
- **Halyard:** A line used to raise or lower a sail.
- **“Hard-a-Lee:”** A command made by the helmsman when the tiller is moved to leeward to tack a sailboat. *Syn. “Coming About, “Tacking,” “Helm’s a- Lee.”*
- **Head Down:** To turn the boat away from the wind. *Syn. Bear Away, Bear Off, Come Down, Fall Off, Head Off.*
- **Head Up:** To turn the boat toward the wind. *Syn. Bear Up, Come Up, Go Up, Harden Up, Luff up.*

## SAILING TERMINOLOGY

- **Head-to-Wind:** When the bow of the boat is pointing directly into the wind, or in the middle of the no-go zone.
- **Heel:** When a boat leans over or tips to one side.
- **Helm:** The tiller or wheel of a boat.
- **Helmsman:** The person who steers or drives a boat. *Syn. Skipper*
- **Hiking:** When a person leans over the side of a boat to counteract heel.
- **In Irons:** When a boat is pointed into the wind and has stopped or is moving backward through the water, and is temporarily unable to turn onto either tack.
- **In the Groove:** When a sailboat is moving well with proper balance and sail trim, and is steered so the sails are working at their best with the telltales flowing properly.

## SAILING TERMINOLOGY

- **Jibe:** Changing from one tack to the other when sailing downwind. The mainsail swings across the boat, which can be a controlled maneuver or can happen unexpectedly as the wind crosses the stern. *Syn. Gybe, Jibing, Gybing*
- **“Jibe Ho:”** A command made by the helmsman as he or she starts to jibe.
- **Keel:** The fixed underwater fin on a sailboat hull which helps provide stability and prevents the boat from slipping sideways.
- **Knot:** One nautical mile per hour. 1 knot equals 1.15 miles per hour.
- **Leeward:** In the opposite direction from the wind source, or where the wind is blowing to. *Syn. Downwind*
- **Leeward Side:** The side of a sailboat or a sail, away from the wind source.

## SAILING TERMINOLOGY

- **Line:** A rope used for a function on the boat, such as a sheet, halyard, cunningham or painter.
- **Luffing:** When the sail is stalling or flapping at its forward edge, or the entire sail is flapping. Syn. *Feathering, High, Light, Pinching, Soft*
- **Lull:** A decrease in wind speed for a short duration.
- **No-Go Zone:** The area into the wind where a sailboat cannot sail, even with the sails pulled in all-the-way. The zone covers the direction pointing directly into the wind source and extending to about 45 degrees on either side of it.
- **Off the Wind:** Any of the points of sail, except sailing upwind.
- **Offshore Wind:** Wind blowing away from the shore to the water. Syn. *Land Breeze*

## SAILING TERMINOLOGY

- **One Design:** Any boat built to conform to rules so that it is identical to all others in the same class.
- **Onshore Wind:** Wind blowing from the water to the shore. Syn. *Sea Breeze*
- **PFD:** A personal flotation device. Syn. *Life Jacket, Life Vest.*
- **Points of Sail:** The headings of a sailboat in relation to the wind, i.e. *close-hauled, close reach, reach, broad reach, run.*
- **Port:** The left side of the boat (when looking forward.)
- **Reach:** Sailing with the wind coming over the side, or abeam. (One of the points of sail.)
- **“Ready About:”** A command made before tacking to ensure everyone is ready to tack. Syn. *“Prepare to Tack,” “Ready to Tack.”*

## SAILING TERMINOLOGY

- **Run:** Sailing away from the wind source with the sails let out all the way. Syn. *Downwind, With the Wind* (One of the points of sail.)
- **Running Rigging:** The lines and associated fittings used to adjust and trim the sails, such as halyards, sheets, outhaul, cunningham or boom vang. Syn. *Control Line, Sail Controls*
- **Safety Position:** When a boat is stopped with the sails eased and flapping with the wind coming from the side.
- **Sail Trim:** The positioning and shape of the sails to the wind.
- **Scull:** To propel a sailboat forward by moving the rudder and tiller side to side repeatedly.
- **Sea Breeze:** Wind resulting from cooler air over the water moving in to replace the warm air that rises over the land.



## SAILING TERMINOLOGY

- **Sheet:** 1. The rope which pulls in or lets out a sail. 2. To adjust a sail by using the sheet. *Syn. Set, Trim, Sheet In, Pull In, Take In.*
- **Sheet Out:** To let out a sail. *Syn. Ease, Let Off*
- **S-Jibe:** A method of jibing a sailboat which results in the mainsail crossing the boat under control. The path of the boat makes an “S.”
- **Squall:** A strong wind of short duration, usually appearing suddenly and accompanied by rain.
- **Starboard:** The right side of a boat (when looking forward.)
- **Tack:** To turn the bow of a sailboat through the wind or no-go zone so that the sails fill on the opposite side. *Syn. Come About.*

## SAILING TERMINOLOGY

- **Tacking:** The maneuver of turning a sailboat through the no-go zone so the sails fill on the opposite tack. *Syn. Coming About*
- **Telltails:** Short pieces of yarn, ribbon, thread, or tape attached to the sail, or on the shrouds which are used to show the air flow over the sail, or the the apparent wind direction (when placed on the shrouds.)
- **Trim:** To adjust a sail by using the sheet. *Syn. Sheet, Set*
- **Upwind:** In the direction of the wind source or where the wind is blowing from. *Syn. Windward. To Weather*
- **Windward:** In the direction toward the wind source, or where the wind is blowing from. *Syn. To Weather, Upwind*
- **Windward Side:** The side of the sailboat or sail toward the wind source. *Syn. High Side, Weather Side, Upwind Side.*
- **Wing and Wing:** Sailing directly downwind with the jib and mainsail set on opposite sides of the boat to capture more wind.

## HOW WELL DO YOU KNOW YOUR SAILING TERMS?

1. The line used to raise a sail is called a \_\_\_\_\_
2. The headings of a sailboat in relation to the wind are called the \_\_\_\_\_
3. To pull in the mainsail, you use the \_\_\_\_\_
4. The yarns on a jib which help you determine if you're sailing close-hauled are called \_\_\_\_\_
5. Another name for a life preserver is called a \_\_\_\_\_ which stands for \_\_\_\_\_
6. The fixed underwater fin, which helps provide stability and prevent the boat from slipping sideways is called a \_\_\_\_\_.
7. The tiller or wheel of a boat is referred to as the \_\_\_\_\_.

## HOW WELL DO YOU KNOW YOUR SAILING TERMS?

8. The left side of the boat is the \_\_\_\_\_ side.
9. The right side of the boat is the \_\_\_\_\_ side.
10. The lines used to adjust and trim the sails are referred to as the \_\_\_\_\_.
11. The shrouds are part of the \_\_\_\_\_.
12. The side of the boat that the wind is blowing over is called the \_\_\_\_\_ side.
13. The side of the boat that the sails are on is the \_\_\_\_\_ side.
14. When a boat is stopped broadside to the wind with her sails eased all the way out, the boat is in the \_\_\_\_\_.
15. When you turn the bow of your sailboat through the wind, you are \_\_\_\_\_.

## HOW WELL DO YOU KNOW YOUR SAILING TERMS?

16. When you turn the stern of your sailboat through the wind you are

\_\_\_\_\_.

17. Name the 5 points of sail:

\_\_\_\_\_.

18. When you push the tiller toward the sail and you are sailing closer to the wind, you are \_\_\_\_\_.

19. If you don't \_\_\_\_\_ your sails, they will start to \_\_\_\_\_

20. When you are sailing downwind, you run the risk of \_\_\_\_\_.

A sign that you are about to \_\_\_\_\_ is the \_\_\_\_\_ comes over.

21. When a boat tips, we say it is \_\_\_\_\_.

22. \_\_\_\_\_ the sheet to spill wind out of your sail, when this happens.

23. A boat must be positioned into the \_\_\_\_\_ in order to raise your sails, before you \_\_\_\_\_.

24. When you turn from a beam reach to a broad reach, you are

\_\_\_\_\_.

# FOR MORE INFORMATION...

## Marine Supply Stores

- West Marine (Stratford, Norwalk, and Stamford)
- Boat Locker (Bridgeport)
- Landfall Navigation (Stamford)
- Bass Pro Shop (Bridgeport)

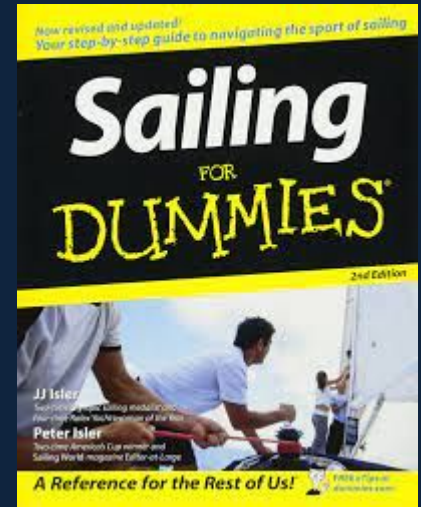

## Safe Boating Courses

- DEEP website

## Private Lessons

- Ginny Worcester

## In Case of Emergency

- Marine Police (203) 254-4800 or 911
- Pequot Yacht Club (203) 255-5740 or Marine Channel 69

## DATES FOR THE NEXT SAFE BOATING SESSIONS



Session 3, May 4: “Seamanship, rules of the road, and emergencies”

- We will be covering seamanship, maneuvering in the harbor safely and efficiently, the rules of the road, and “what happens if” situations i.e., running aground, becoming becalmed, man overboard and squall procedure.
- Test review, as well.

CSF Sailing Dockside Schedule – at Ye Yacht Yard

- ✓ Session 1 – Saturday, June 5, 9am
- ✓ Session 2 – Saturday, June 12, 9am



# QUESTIONS AND ANSWERS



**SAFE, HAPPY SAILING!**

